

TNG	Version: 2	Style: Y0204	Age Group: Adult
	Brand: TNG Fashion	Name: Nano 3.0 mask	
	Season: 2020	Gender: Unisex	
Group: Mask		Sizing: M,L	
Tech pack reference: Proto		Finishing: Unwash	
Number: 001			Date: 26/05/2020
Spec Status: Bulk			

TABLE OF CONTENTS

COMPONENT LAST UPDATE

LIST

001: Cover Page Design	26-05-2020
BOM	
002: Structure	26-05-2020
003: Sketch	26-05-2020
004: Graded	26-05-2020
measurement	26-05-2020
005: Design BOM	26-05-2020



Note:

TNG	Version: 2	Style: Y0204	Age Group: Adult
	Brand: TNG Fashion	Name: Nano 3.0 mask	
	Season: 2020	Gender: Unisex	
Group: Mask		Sizing: M,L	
Tech pack reference: Proto		Finishing: Unwash	
Number: 001		Date: 26/05/2020	
Spec Status: Bulk			

Nano 3.0 mask – 3 layer

Style: Y0204

Front



Biside



Logo TNG
LxW: 2,2cm x 0.5cm



Logo TNG
KT DxR: 2.2cm x 0.5cm

Note:

Structure

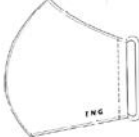
TNG	Version: 2	Style: Y0204	Age Group: Adult
	Brand: TNG Fashion	Name: Nano 3.0 mask	
	Season: 2020	Gender: Unisex	
Group: Mask		Sizing: M,L	
Tech pack reference: Proto		Finishing: Unwash	
Number: 001		Date: 26/05/2020	
Spec Status: Bulk			

CONSTRUCTION

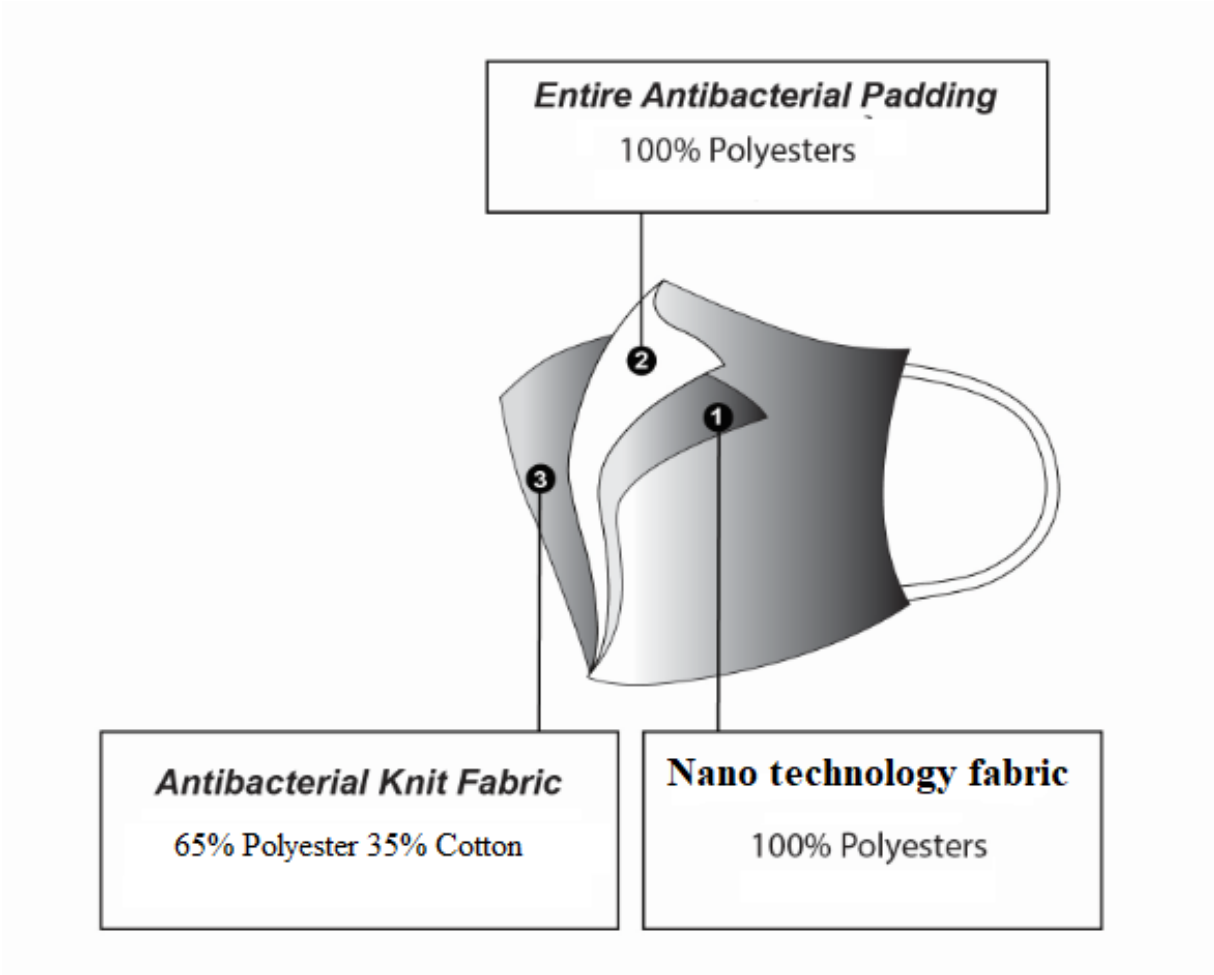

Note:

TNG	Version: 2	Style: Y0204	Age Group: Adult
	Brand: TNG Fashion	Name: Nano 3.0 mask	
	Season: 2020	Gender: Unisex	
Group: Mask		Sizing: M,L	
Tech pack reference: Proto		Finishing: Unwash	
Number: 001		Date: 26/05/2020	
Spec Status: Bulk			

STITCH KEY

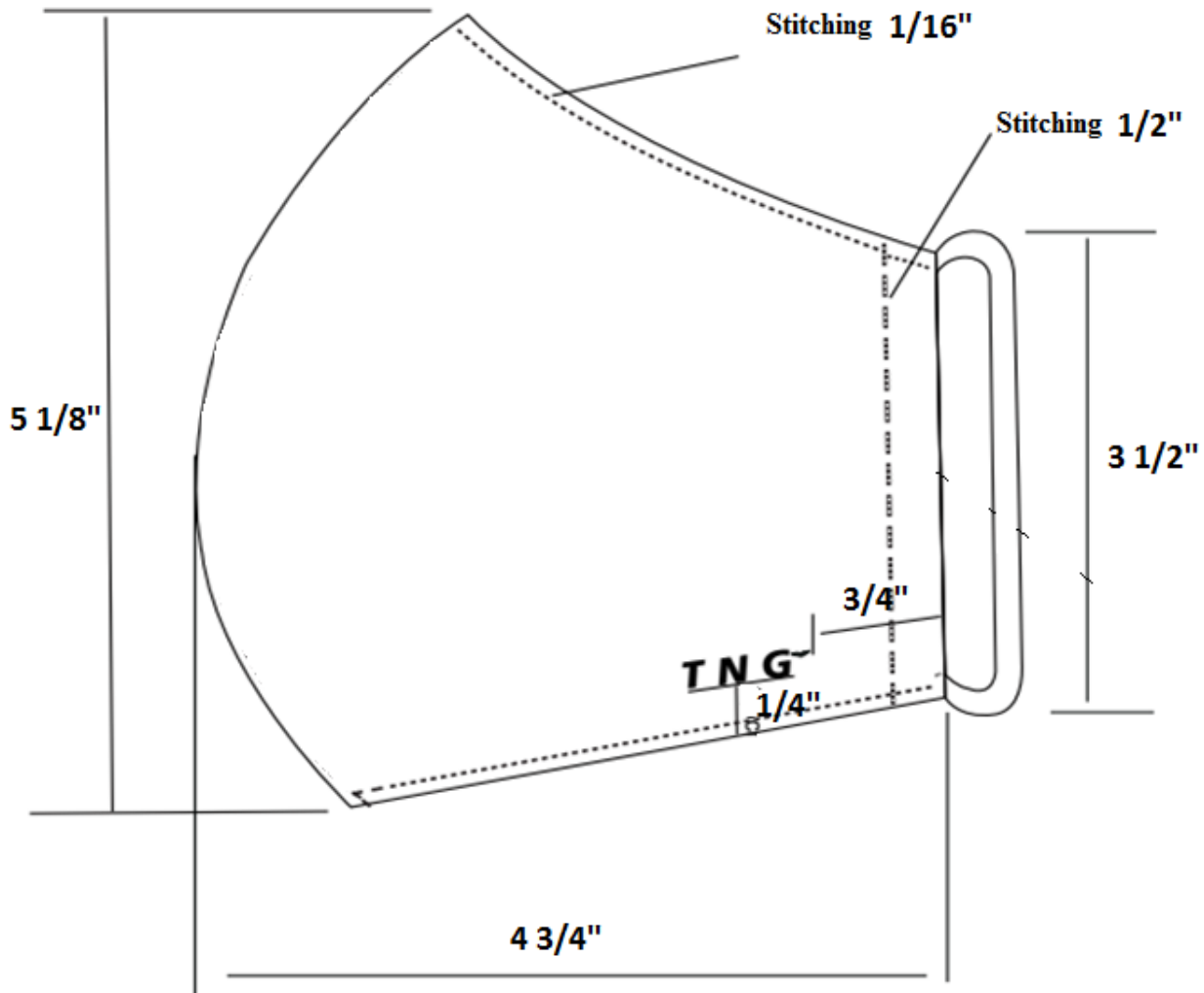

Note:

TNG	Version: 2	Style: Y0204	Age Group: Adult
	Brand: TNG Fashion	Name: Nano 3.0 mask	
	Season: 2020	Gender: Unisex	
Group: Mask		Sizing: M,L	
Tech pack reference: Proto		Finishing: Unwash	
Number: 001			Date: 26/05/2020
Spec Status: Bulk			

Measurement

UOM: inhch

POM code	POM name	Tol (+/-)	M	L
001	½ Length	3/16	4 ¾’’	5 1/8’’
002	Width – at highest point	3/16	5 1/8’’	5 ½’’
003	½ Ear loop (relaxed)	3/16	3 ½’’	4 1/8’’

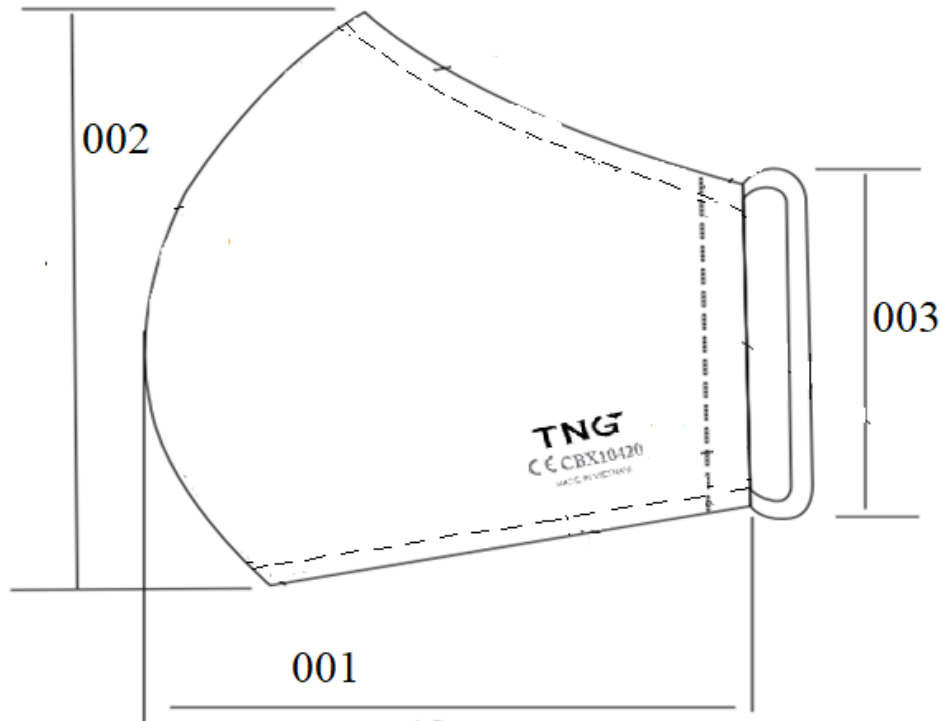

Note:

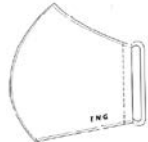
TNG	Version: 2	Style: Y0204	Age Group: Adult
	Brand: TNG Fashion	Name: Nano 3.0 mask	
	Season: 2020	Gender: Unisex	
Group: Mask		Sizing: M,L	
Tech pack reference: Proto		Finishing: Unwash	
Number: 001			Date: 26/05/2020
Spec Status: Bulk			

Section: Fabrics							
Placeme nt	Material Role	Article Part Name	Supplier	Consumption	UOM	Color	Comment
	Outer-Nano technology fabric	100% Polyester	Faslink	0.029	M		
	Inner- Antibacterial knit fabric	65% polyeter, 35% cotton	Lami	0.0225	M		
	Antibacterial padding	50gsm 100% Polyester	TNG	0.0275	M		
	Ear loop	98% Cotton, 2 % Spandex,	Lami	0.005	M		

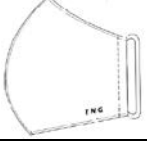
TNG	Version: 2	Style: Y0204	Age Group: Adult
	Brand: TNG Fashion	Name: Nano 3.0 mask	
	Season: 2020	Gender: Unisex	
Group: Mask		Sizing: M,L	
Tech pack reference: Proto		Finishing: Unwash	
Number: 001			Date: 26/05/2020
Spec Status: Bulk			

Section: Trims

Placeme nt	Material Role	Article Part Name	Supplier	Consumption	UOM	Color	Comment

Section: Labels

Placeme nt	Material Role	Article Part Name	Supplier	Consumption	UOM	Color	Comment
		TNG logo Heat transfer	TNG	1	pcs		

Section: Packaging

Placeme nt	Material Role	Article Part Name	Supplier	Consumption	UOM	Color	Comment
	Poly bag			0.2	pcs		
	Carton box			0.002	pcs		
	PE polybag			0.002	pcs		

Section: Others

Placeme nt	Material Role	Article Part Name	Supplier	Consumption	UOM	Color	Comment
	Threads	60s/3		0.003	cons		

TNG	Version: 2	Style: Y0204	Age Group: Adult
	Brand: TNG Fashion	Name: Nano 3.0 mask	
	Season: 2020	Gender: Unisex	
Group: Mask		Sizing: M,L	
Tech pack reference: Proto		Finishing: Unwash	
Number: 001		Date: 26/05/2020	
Spec Status: Bulk			

Sterilization process before packing

- *Step 1:* All the products must be run through the metal detector machine in order to prevent metal.



- *Step 2:* All the products after run through the metal detector and pass will transfer to drying area.



- *Step 3:* All the products will be transfer antiseptic room at least 24h (prior to) packing.



Note:

TNG	Version: 2	Style: Y0204	Age Group: Adult
	Brand: TNG Fashion	Name: Nano 3.0 mask	
	Season: 2020	Gender: Unisex	
Group: Mask		Sizing: M,L	
Tech pack reference: Proto		Finishing: Unwash	
Number: 001		Date: 26/05/2020	
Spec Status: Bulk			

PACKING STANDARDS

**TECHNICAL DEPARTMENT
PACKING INSTRUCTION OF MASK
(5 Pcs in 1 Poly Bag)**

Note: Clean finishing and Iron all products before packing

1. Step 1: Folded the mask in half then stack the 5 masks on top of each other, the TNG logo faces up (follow to Figure 1)
 - TNG poly bag: Width: 18cm x Length: 21cm(Figure 2)
 - When putting the mask in the poly bag, please note that the TNG logo heat transfer is the face side (the plastic box showing the logo). (Follow to figure 3,4)
 - Note: *The size in the poly bag should be DTM with the size of the product.*
 - Note: Don't mix the size/color in a poly bag.
 - Remove seal tape at the opening of the poly bag and finish the packing (Count 5 pcs/bag)

Figure 1	Figure 2	Figure 3
		

2. Step 2: Carton dimension: Length: 55cm x Width: 40cm x Height: 26cm

TNG logo brand is printed at outside

- The carton includes 2 cardboard sheet with a master bag which covers all polybag.



Note:

Gauze mask Standards Manual

TNG	Version: 2	Style: Y0204	Age Group: Adult
	Brand: TNG Fashion	Name: Nano 3.0 mask	
	Season: 2020	Gender: Unisex	
Group: Mask		Sizing: M,L	
Tech pack reference: Proto		Finishing: Unwash	
Number: 001		Date: 26/05/2020	
Spec Status: Bulk			

- 3. Step 3: Create 6 columns of the poly bag as the picture below, the balance should be placed in the middle. Please note that the face side is showing up.
 - Remark "MIX" in shipping mark if mix lining color of the mask in last carton.
- 4. Step 4: After placing enough 500pcs in the carton,
 - Close master polybag by seal tape.
 - Put cardboard sheets in top & bottom of the carton and stick the seal tape at outside of the carton.

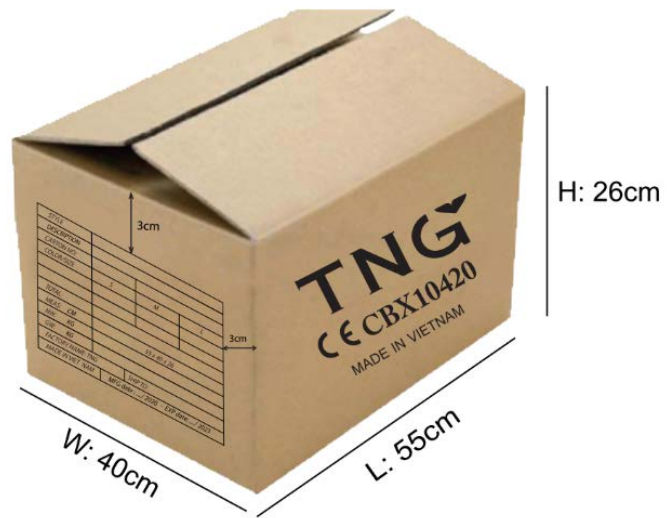

Note:

TNG	Version: 2	Style: Y0204	Age Group: Adult
	Brand: TNG Fashion	Name: Nano 3.0 mask	
	Season: 2020	Gender: Unisex	
Group: Mask		Sizing: M,L	
Tech pack reference: Proto		Finishing: Unwash	
Number: 001		Date: 26/05/2020	
Spec Status: Bulk			

NANO'S SPECIAL FEATURE

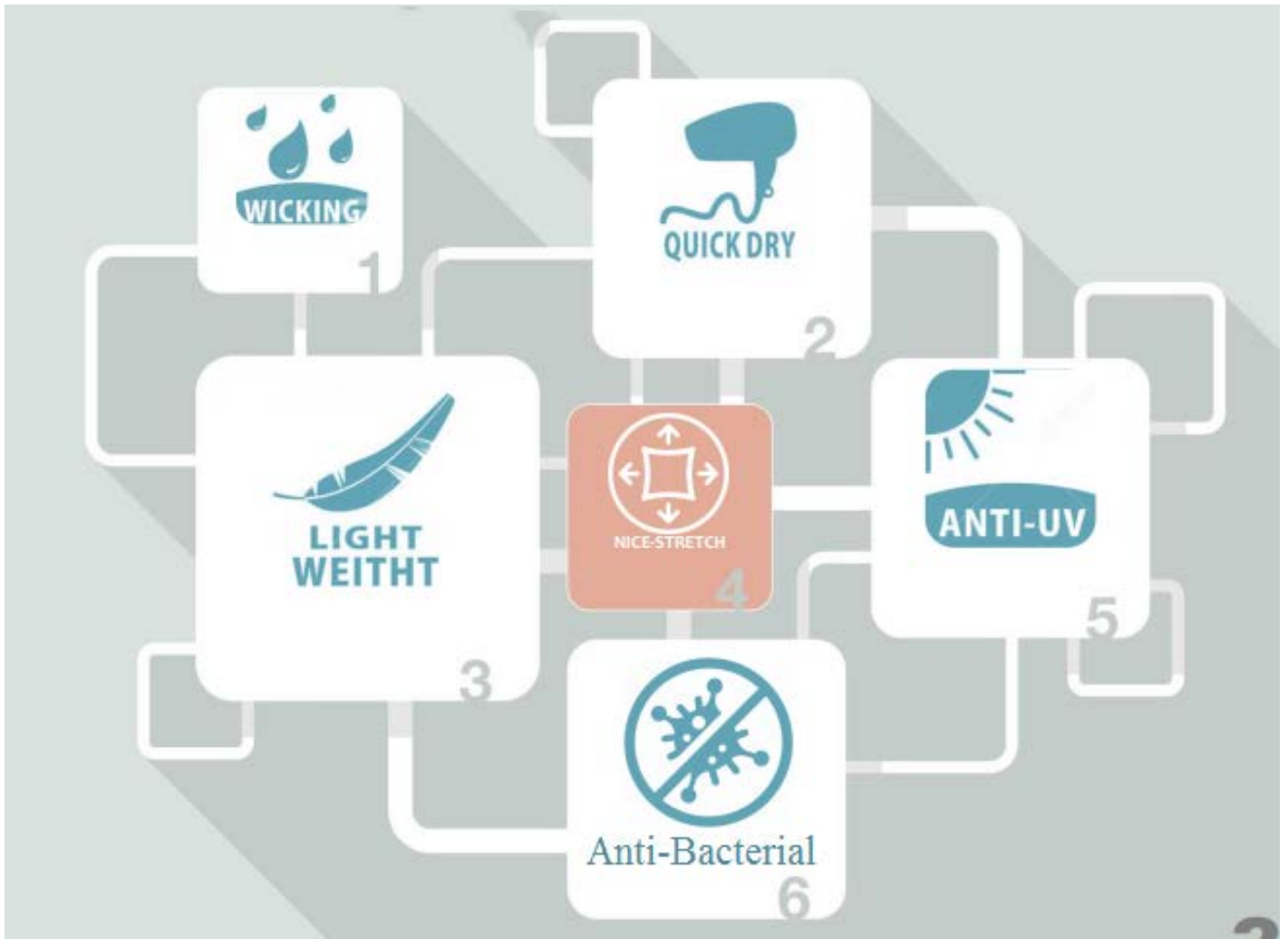

Note: